

Composite dry sliding bushings, metric dimensions

Principal dimensions			Basic load ratings		Mass	Designation
d	D	B	dynamic C	static C0		
mm	12	20	kN		kg	-
10			16	50	0,0051	PCM 101220 E

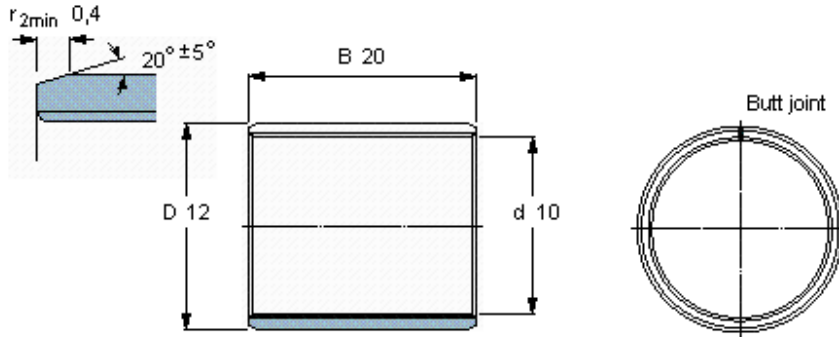

Specific load factor
Material constant

K 80
K_M 480